

GENERAC®

Protector® QS Series

PROTECTOR® QS SERIES Standby Generators Liquid-Cooled Gas Engine

INCLUDES:

- Two Line LCD Multilingual Digital Evolution™ Controller (English/Spanish/French/Portuguese) with external viewing window for easy indication of generator status and breaker position.
- True Power™ Electrical Technology
- Isochronous Electronic Governor
- Sound Attenuated Enclosure
- Closed Coolant Recovery System
- Smart Battery Charger
- UV/Ozone Resistant Hoses
- ±1% Voltage Regulation
- Natural Gas or LP Operation
- 5 Year Limited Warranty
- UL 2200 Listed

Standby Power Rating

- Model RG022 (Aluminum - Gray) - 22 kW 60 Hz
- Model RG027 (Aluminum - Gray) - 27 kW 60 Hz
- Model RG032 (Aluminum - Gray) - 32 kW 60 Hz
- Model RG038 (Aluminum - Gray) - 38 kW 60 Hz
- Model RG048 (Aluminum - Gray) - 48 kW 60 Hz



QUIET-TEST™

Meets EPA Emission Regulations
22 & 27 kW are CA/MA emissions compliant
48 kW meets CA/MA emissions requirements with optional catalyst
32 & 38 kW not for sale in CA/MA

FEATURES

- **INNOVATIVE DESIGN & PROTOTYPE TESTING** are key components of GENERAC'S success in "IMPROVING POWER BY DESIGN." But it doesn't stop there. Total commitment to component testing, reliability testing, environmental testing, destruction and life testing, plus testing to applicable CSA, NEMA, EGSA, and other standards, allows you to choose GENERAC POWER SYSTEMS with the confidence that these systems will provide superior performance.
- **TEST CRITERIA:**
 - ✓ PROTOTYPE TESTED
 - ✓ SYSTEM TORSIONAL TESTED
 - ✓ NEMA MG1-22 EVALUATION
 - ✓ MOTOR STARTING ABILITY
- **SOLID-STATE, FREQUENCY COMPENSATED VOLTAGE REGULATION.** This state-of-the-art power maximizing regulation system is standard on all Generac models. It provides optimized FAST RESPONSE to changing load conditions and MAXIMUM MOTOR STARTING CAPABILITY by electronically torque-matching the surge loads to the engine. Digital voltage regulation at ±1%.
- **SINGLE SOURCE SERVICE RESPONSE** from Generac's extensive dealer network provides parts and service know-how for the entire unit, from the engine to the smallest electronic component.
- **GENERAC TRANSFER SWITCHES.** Long life and reliability are synonymous with GENERAC POWER SYSTEMS. One reason for this confidence is that the GENERAC product line includes its own transfer systems and controls for total system compatibility.

GENERAC®



22 • 27 • 32 • 38 • 48 kW

GENERATOR SPECIFICATIONS

Type	Synchronous
Rotor Insulation Class	H (22 & 27 kW) or F (32, 38 & 48 kW)
Stator Insulation Class	H
Telephone Interference Factor (TIF)	<50
Alternator Output Leads 1-Phase	4 wire
Alternator Output Leads 3-Phase	6 wire
Bearings	Sealed Ball
Coupling	Flexible Disc
Excitation System	Direct

VOLTAGE REGULATION

Type	Electronic
Sensing	Single Phase
Regulation	± 1%

GOVERNOR SPECIFICATIONS

Type	Electronic
Frequency Regulation	Isochronous
Steady State Regulation	± 0.25%

ELECTRICAL SYSTEM

Battery Charge Alternator	12 Volt 30 Amp
Static Battery Charger	2.5 Amp
Recommended Battery	Group 26 (22, 27, 32 & 38 kW) or Group 24F (48 kW), 525CCA
System Voltage	12 Volts

GENERATOR FEATURES

Revolving field heavy duty generator Directly connected to the engine Operating temperature rise 120 °C above a 40 °C ambient Class H insulation is rated at 150 °C rise at 25 °C ambient Class F insulation is rated at 145 °C rise at 25 °C ambient All models fully prototyped tested

ENCLOSURE FEATURES

Aluminum weather protective enclosure	Ensures protection against mother nature. Electrostatically applied textured epoxy paint for added durability.
Enclosed critical grade muffler	Quiet, critical grade muffler is mounted inside the unit to prevent injuries.
Small, compact, attractive	Makes for an easy, eye appealing installation.
SAE	Sound attenuated enclosure ensures quiet operation.

ENGINE SPECIFICATIONS: 22, 27, 32 & 38 kW

Make	Generac
Model	In-line
Cylinders	4
Displacement (Liters)	2.4
Bore (in/mm)	3.41/86.5
Stroke (in/mm)	3.94/100
Compression Ratio	9.5:1
Intake Air System	Naturally Aspirated (22 & 27 kW) or Turbocharged/Aftercooled (32 & 38 kW)
Lifter Type	Hydraulic

ENGINE SPECIFICATIONS: 48 kW

Make	Generac
Model	V-Type
Cylinders	8
Displacement (Liters)	5.4
Bore (in/mm)	3.55/90.2
Stroke (in/mm)	4.17/105.9
Compression Ratio	9:1
Intake Air System	Naturally Aspirated
Lifter Type	Hydraulic

ENGINE LUBRICATION SYSTEM

Oil Pump Type	Gear
Oil Filter Type	Full flow spin-on cartridge
Crankcase Capacity (qt/l)	4/3.8 (22, 27, 32 & 38 kW) or 6/5.7 (48 kW)

ENGINE COOLING SYSTEM

Type	Closed
Water Pump	Belt driven
Fan Speed (rpm)	1980 - 22 & 27 kW 1500 - 32 & 38 kW 1954 - 48 kW
Fan Diameter (in/mm)	18.1/459.7 (22 & 27 kW) or 22/558.8 (32, 38 & 48 kW)
Fan Mode	Pusher (22 & 27 kW) or Puller (32, 38 & 48 kW)

FUEL SYSTEM

Fuel Type	Natural gas, propane vapor
Carburetor	Down Draft
Secondary Fuel Regulator	Standard
Fuel Shut Off Solenoid	Standard
Operating Fuel Pressure	5-14" water column/9-26 mm HG

(All ratings in accordance with BS5514, ISO3046, ISO8528, SAE J1349 and DIN6271)

22 • 27 • 32 • 38 • 48 kW

GENERATOR OUTPUT VOLTAGE/kW - 60 Hz

		kW LPG	Amp LPG	kW Nat. Gas	Amp Nat. Gas	CB Size (Both)
RG022	120/240 V, 1Ø, 1.0 pf	22	92	22	92	100
	120/208 V, 3Ø, 0.8 pf	22	76	22	76	80
	120/240 V, 3Ø, 0.8 pf	22	66	22	66	80
RG027	120/240 V, 1Ø, 1.0 pf	27	113	25	104	125
	120/208 V, 3Ø, 0.8 pf	27	94	25	87	100
	120/240 V, 3Ø, 0.8 pf	27	81	25	75	90
RG032	120/240 V, 1Ø, 1.0 pf	32	133	32	133	150
	120/208 V, 3Ø, 0.8 pf	32	111	32	111	125
	120/240 V, 3Ø, 0.8 pf	32	96	32	96	100
	277/480 V, 3Ø, 0.8 pf	32	48	32	48	60
RG038	120/240 V, 1Ø, 1.0 pf	38	158	38	158	175
	120/208 V, 3Ø, 0.8 pf	38	132	38	132	150
	120/240 V, 3Ø, 0.8 pf	38	114	38	114	125
	277/480 V, 3Ø, 0.8 pf	38	57	38	57	60
RG048	120/240 V, 1Ø, 1.0 pf	48	200	48	200	200
	120/208 V, 3Ø, 0.8 pf	48	167	48	167	175
	120/240 V, 3Ø, 0.8 pf	48	144	48	144	150
	277/480 V, 3Ø, 0.8 pf	48	72	48	72	80

SURGE CAPACITY IN AMPS

		Voltage Dip @ < .4 pf	
		15%	30%
RG022	120/240 V, 1Ø	55	135
	120/208 V, 3Ø	40	92
	120/240 V, 3Ø	35	80
RG027	120/240 V, 1Ø	62	170
	120/208 V, 3Ø	70	120
	120/240 V, 3Ø	61	103
RG032	120/240 V, 1Ø	75	180
	120/208 V, 3Ø	87	210
	120/240 V, 3Ø	75	182
	277/480 V, 3Ø	36	87
RG038	120/240 V, 1Ø	75	180
	120/208 V, 3Ø	87	210
	120/240 V, 3Ø	75	182
	277/480 V, 3Ø	36	87
RG048	120/240 V, 1Ø	85	195
	120/208 V, 3Ø	90	218
	277/480 V, 3Ø	36	87

ENGINE FUEL CONSUMPTION

		Natural Gas		Propane		
		(ft³/hr)	(m³/hr)	(gal/hr)	(l/hr)	(ft³/hr)
RG022	Exercise cycle	42	1.2	0.44	1.7	16
	25% of rated load	100	2.8	1.1	4.2	40
	50% of rated load	190	5.4	2.1	7.8	75
	75% of rated load	255	7.2	2.8	10.5	101
	100% of rated load	316	9	3.4	13	125
RG027	Exercise cycle	42	1.2	0.44	1.7	16
	25% of rated load	108	3.1	1.2	4.5	43
	50% of rated load	197	5.6	2.1	8.1	78
	75% of rated load	287	8.2	3.1	11.8	114
	100% of rated load	359	10.2	3.9	14.8	143
RG032	Exercise cycle	53	1.5	0.5	2	18
	25% of rated load	138	3.9	1.5	5.7	55
	50% of rated load	251	7.1	2.8	10.6	102
	75% of rated load	350	9.9	3.8	14.4	138
	100% of rated load	448	12.7	4.9	18.5	178
RG038	Exercise cycle	53	1.5	0.5	2	18
	25% of rated load	162	4.6	1.8	6.8	65
	50% of rated load	297	8.4	3.3	12.5	120
	75% of rated load	413	11.7	4.5	17	164
	100% of rated load	533	15.1	5.8	22	211
RG048	Exercise cycle	95	2.7	1	3.9	38
	25% of rated load	204	5.8	2.16	8.5	82
	50% of rated load	392	11.1	4.14	15.7	151
	75% of rated load	547	15.5	5.8	22.8	220
	100% of rated load	756	21.5	7.96	31.3	302

Note: **Fuel pipe must be sized for full load.**

For Btu content, multiply ft³/hr x 2520 (LP) or ft³/hr x 1000 (NG)

For megajoule content, multiply m³/hr x 93.15 (LP) or m³/hr x 37.26 (NG)

Refer to "Emissions Data Sheets" for maximum fuel flow for EPA and SCAQMD permitting purposes.

STANDBY RATING: Standby ratings apply to installations served by a reliable utility source. The standby rating is applicable to varying loads for the duration of a power outage. There is no overload capability for this rating. Ratings are in accordance with ISO-3046-1. Design and specifications are subject to change without notice.

22 • 27 • 32 • 38 • 48 kW

operating data

ENGINE COOLING

	22 kW	27 kW	32 & 38 kW	48 kW
Air flow (inlet air including alternator and combustion air in cfm/cmm)	2400/68	2400/68	2200/62.3	4350/123.2
System coolant capacity (gal/liters)	2.5/9.5	2.5/9.5	2.5/9.5	3/11.4
Heat rejection to coolant (BTU per hr/MJ per hr)	99,000/104.5	105,000/110.8	145,000/153	186,000/196.2
Maximum operation air temperature on radiator (°C/°F)	60/150			
Maximum ambient temperature (°C/°F)	50/140			

COMBUSTION REQUIREMENTS

Flow at rated power (cfm/cmm)	68/1.9	68/1.9	106/3	163/4.6
-------------------------------	--------	--------	-------	---------

SOUND EMISSIONS

Sound output in dB(A) at 23 ft (7 m) with generator in exercise mode*	61	61	58	63
Sound output in dB(A) at 23 ft (7 m) with generator operating at normal load*	70	70	64	68

*Sound levels are taken from the front of the generator. Sound levels taken from other sides of the generator may be higher depending on installation parameters.

EXHAUST

Exhaust flow at rated output (cfm/cmm)	165/4.7	180/5.1	300/8.5	414/11.7
Exhaust temperature at muffler outlet (°C/°F)	482/900	538/1000	579/1075	552/1025

ENGINE PARAMETERS

Rated Synchronous rpm	1800
-----------------------	------

POWER ADJUSTMENT FOR AMBIENT CONDITIONS

Temperature Deration3% for every 10 °C above 25 °C or 1.65% for every 10 °F above 77 °F
 Altitude Deration (22, 27 & 48 kW)1% for every 100 m above 183 m or 3% for every 1000 ft above 600 ft
 Altitude Deration (32 & 38 kW)1% for every 100 m above 915 m or 3% for every 1000 ft above 3000 ft

CONTROLLER FEATURES

2-Line Plain Text LCD DisplaySimple user interface for ease of operation.
 Mode Switch: AutoAutomatic Start on Utility failure. 7 day exerciser
 OffStops unit. Power is removed. Control and charger still operate.
 ManualStart with starter control, unit stays on. If utility fails, transfer to load takes place.
 Programmable start delay between 10-30 secondsStandard
 Engine Start SequenceCyclic cranking: 16 sec on, 7 rest (90 sec maximum duration)
 Engine Warm-up5 sec
 Engine Cool-Down1 min
 Starter Lock-outStarter cannot re-engage until 5 sec after engine has stopped.
 Smart Battery ChargerStandard
 Automatic Voltage Regulation with Over and Under Voltage ProtectionStandard
 Automatic Low Oil Pressure ShutdownStandard
 Overspeed ShutdownStandard, 72 Hz
 High Temperature ShutdownStandard
 Overcrank ProtectionStandard
 Safety FusedStandard
 Failure to Transfer ProtectionStandard
 Low Battery ProtectionStandard
 50 Event Run LogStandard
 Future Set Capable ExerciserStandard
 Incorrect Wiring ProtectionStandard
 Internal Fault ProtectionStandard
 Common External Fault CapabilityStandard
 Governor Failure ProtectionStandard

Model #	Product	Description
006463-3	Mobile Link™	Generac's Mobile Link allows you to check the status of your generator from anywhere that you have access to an Internet connection from a PC or with any smart device. You will even be notified when a change in the generator's status occurs via e-mail or text message. Note: Harness Adapter Kit required.
006478-0	Harness Adapter Kit	The Harness Adapter Kit is required to make liquid-cooled units compatible with Mobile Link™.
005630-1 - 22, 27, 32 & 38 kW 005632-1 - 48 kW	Cold Weather Kit	If the temperature regularly falls below 32 °F (0 °C), install a cold weather kit to maintain optimal battery temperature. Kit consists of battery warmer with thermostat built into the wrap.
005616-0 - 22, 27, 32 & 38 kW 006204-0 - 48 kW	Extreme Cold Weather Kit	Recommended where the temperature regularly falls below 32 °F (0 °C) for extended periods of time. For liquid cooled units only.
005651-0	Base Plug Kit	Add base plugs to the base of the generator to keep out debris.
005704-0	Paint Kit	If the generator enclosure is scratched or damaged, it is important to touch-up the paint to protect from future corrosion. The paint kit includes the necessary paint to properly maintain or touch-up a generator enclosure.
005656-0 - 22 & 27 kW 005984-0 - 32 & 38 kW 006205-0 - 48 kW	Scheduled Maintenance Kit	The Liquid-Cooled Scheduled Maintenance Kits offer all the hardware necessary to perform complete maintenance on Generac liquid-cooled generators.
006664-0	Wireless Remote	Completely wireless and battery powered, Generac's wireless remote monitor provides you with instant status information without ever leaving the house.
006665-0	Wireless Remote Extension Harness	Recommended for use with the Wireless Remote on units up to 60 kW, required for use on units 70 kW or greater.
006873-0	Smart Management Module (50 Amps)	Smart Management Modules are used in conjunction with the Automatic Transfer Switch to increase its power management capabilities. It provides additional power management flexibility not found in any other power management system.
006510-0	E-Stop	E-stop allows for immediate fuel shutoff and generator shutdown in the event of an emergency.

22 & 27 kW

Drawing #0K8624-A (1 of 2)

SERVICE ITEM	2.4L
OIL FILL CAP	EITHER SIDE
OIL DIP STICK	RIGHT SIDE
OIL FILTER	RIGHT SIDE
OIL DRAIN HOSE	LEFT SIDE
RADIATOR DRAIN	LEFT SIDE
COOLANT RECOVERY BOTTLE	LEFT SIDE
RADIATOR FILL CAP	ROOF TOP
AIR CLEANER ELEMENT	LEFT SIDE
SPARK PLUGS	LEFT SIDE
MUFFLER	SEE NOTE 11
DRIVE BELT	EITHER SIDE
FAN BELT	SEE NOTE 11
BATTERY	LEFT SIDE

REFERENCE OWNERS MANUAL FOR PERIODIC REPLACEMENT PART LISTINGS.

- NOTES:
1. MINIMUM RECOMMENDED CONCRETE PAD SIZE: 1092 (43") WIDE X 1885 (74.2") LONG. REFERENCE INSTALLATION GUIDE SUPPLIED WITH UNIT FOR CONCRETE PAD GUIDELINES
 2. ALLOW SUFFICIENT ROOM ON ALL SIDES OF THE GENERATOR FOR MAINTENANCE AND SERVICING. THIS UNIT MUST BE INSTALLED IN ACCORDANCE WITH CURRENT APPLICABLE NFPA 37 AND NFPA 70 STANDARDS AS WELL AS ANY OTHER FEDERAL, STATE, AND LOCAL CODES.
 3. CONTROL PANEL / CIRCUIT BREAKER INFORMATION:
- SEE SPECIFICATION SHEET OR OWNERS MANUAL
- ACCESSIBLE THROUGH CUSTOMER ACCESS ASSEMBLY COVER PANEL ON REAR OF GENERATOR. THE STUB-UP AREAS AS FOLLOWS:
- HIGH VOLTAGE CONNECTION INCLUDING AC LOAD LEAD, CONDUIT CONNECTION
- NEUTRAL CONNECTION, BATTERY CHARGER 120 VOLT AC (0.5 AMP MAX) CONNECTION.
- CENTER OF GRAVITY AND WEIGHT MAY CHANGE DUE TO UNIT OPTIONS.
 5. CENTER OF GRAVITY AND WEIGHT MAY CHANGE DUE TO UNIT OPTIONS.
 6. BOTTOM OF GENERATOR SET MUST BE ENCLOSED TO PREVENT PEST INTRUSION AND RECIRCULATION OF DISCHARGE AIR AND/OR IMPROPER COOLING AIR FLOW.
 7. REFERENCE OWNERS MANUAL FOR LIFTING WARNINGS.
 8. MOUNTING BOLTS OR STUDS TO MOUNTING SURFACE SHALL BE 5/8-11 GRADE 5 (USE STANDARD SAE TORQUE SPECS)
 9. MUST ALLOW FREE FLOW OF INTAKE AIR, DISCHARGE AIR AND EXHAUST. SEE SPEC SHEET FOR MINIMUM AIR FLOW AND MAXIMUM RESTRICTION REQUIREMENTS.
 10. GENERATOR MUST BE INSTALLED SUCH THAT FRESH COOLING AIR IS AVAILABLE AND THAT DISCHARGE AIR FROM RADIATOR IS NOT RECIRCULATED.
 11. EXHAUST MUFFLER AND FAN BELT ENCLOSED WITHIN GENERATOR ENCLOSURE, REMOVE FRONT PANEL TO ACCESS.

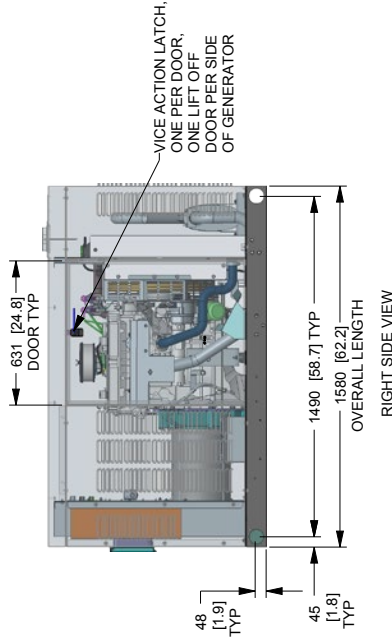
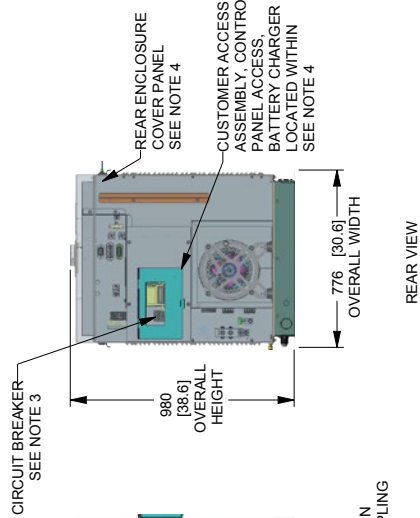
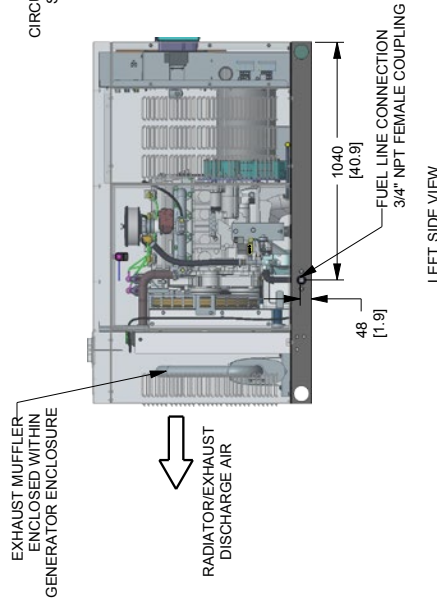
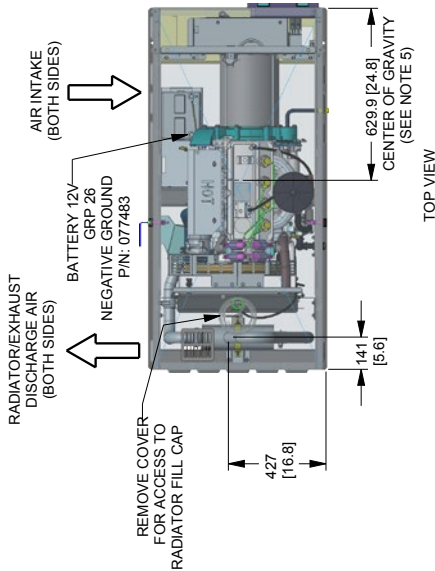

ENGINE/KW	ENCLOSURE MATERIAL	WEIGHT DATA			
		WEIGHT ONLY KG (LBS)	SHIPPING SKID KG (LBS)	WEIGHT KG (LBS)	SHIPPING WEIGHT KG (LBS)
2.4L 22KW	AL	410.5 [905]	30 [66]	30 [66]	440 [971]
2.4L 27KW	AL	426 [940]	30 [66]	30 [66]	456 [1006]

DIMENSIONS: MM [INCH]

22 & 27 kW

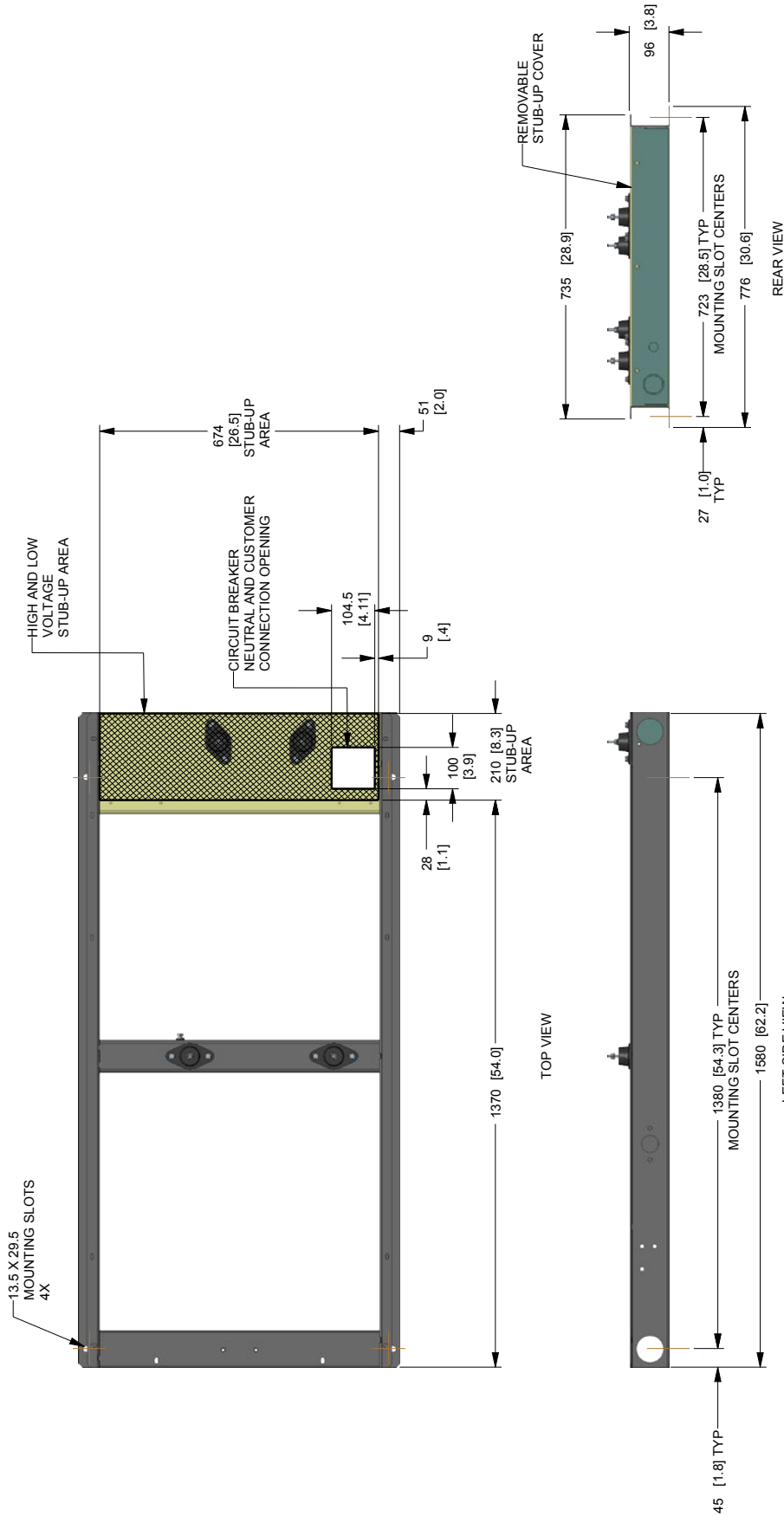

DIMENSIONS: MM [INCH]

32 & 38 kW

Drawing #0K9268-A (1 of 2)

- NOTES:**
- MINIMUM RECOMMENDED CONCRETE PAD SIZE: 1194 (47") WIDE X 2265 (88 8") LONG. REFERENCE INSTALLATION GUIDE SUPPLIED WITH UNIT FOR CONCRETE PAD GUIDELINES.
 - ALLOW SUFFICIENT ROOM ON ALL SIDES OF THE GENERATOR FOR MAINTENANCE AND SERVICING. THIS UNIT MUST BE INSTALLED IN ACCORDANCE WITH CURRENT APPLICABLE NFPA 37 AND NFPA 70 STANDARDS AS WELL AS ANY OTHER FEDERAL, STATE AND LOCAL CODES.
 - CONTROL PANEL / CIRCUIT BREAKER INFORMATION:
 - SEE SPECIFICATION SHEET OR OWNERS MANUAL
 - ACCESSIBLE THROUGH CUSTOMER ACCESS ASSEMBLY DOOR ON REAR OF GENERATOR.
 - REMOVE THE REAR ENCLOSURE COVER PANEL TO ACCESS
 - THE STUB-UP AREAS AS FOLLOWS:
 - HIGH VOLTAGE CONNECTION INCLUDING AC LOAD LEAD, CONDUIT CONNECTION, NEUTRAL CONNECTION, AND BATTERY CHARGER 120 VOLT AC (0.5 AMP MAX) CONNECTION.
 - LOW VOLTAGE CONNECTION INCLUDING TRANSFER SWITCH CONTROL WIRES.
 - CENTER OF GRAVITY AND WEIGHT MAY CHANGE DUE TO UNIT OPTIONS.
 - BOTTOM OF GENERATOR SET MUST BE ENCLOSED TO PREVENT PEST INTRUSION AND RECIRCULATION OF DISCHARGE AIR AND/OR IMPROPER COOLING AIR FLOW.
 - REFERENCE OWNERS MANUAL FOR LIFTING WARNINGS.
 - MOUNTING BOLTS OR STUDS TO MOUNTING SURFACE SHALL BE 5/8-11 GRADE 5 (USE STANDARD SAE TORQUE SPECS)
 - MUST ALLOW FREE FLOW OF INTAKE AIR, DISCHARGE AIR AND EXHAUST. SEE SPEC SHEET FOR MINIMUM AIR FLOW AND MAXIMUM RESTRICTION REQUIREMENTS.
 - GENERATOR MUST BE INSTALLED SUCH THAT FRESH COOLING AIR IS AVAILABLE AND THAT DISCHARGE AIR FROM RADIATOR IS NOT RECIRCULATED.
 - EXHAUST MUFFLER AND FAN BELT ARE ENCLOSED WITHIN GENERATOR ENCLOSURE. REMOVE FRONT PANEL TO ACCESS.

SERVICE ITEM	2.4L
EITHER SIDE	
OIL FILL CAP	
OIL DIP STICK	
OIL FILTER	
OIL DRAIN HOSE	
RADIATOR DRAIN HOSE	
COOLANT RECOVERY BOTTLE	
RADIATOR FILL CAP ACCESS	
AIR CLENER ELEMENT	
SPARK PLUGS	
MUFFLER	
DRIVE BELT	
FAN BELT	
BATTERY	

REFERENCE OWNERS MANUAL FOR PERIODIC REPLACEMENT PART LISTINGS.

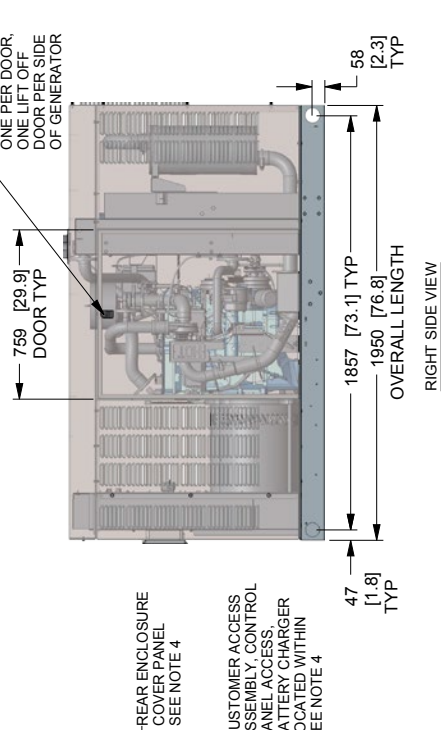
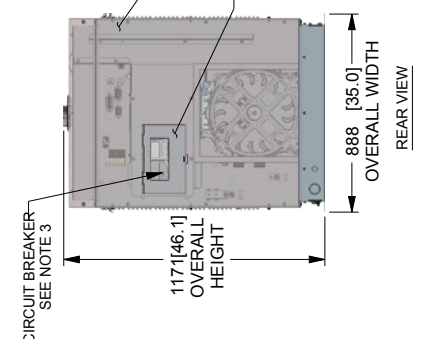
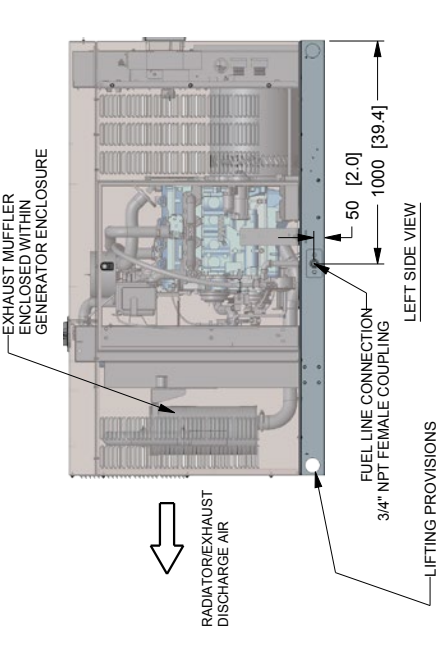
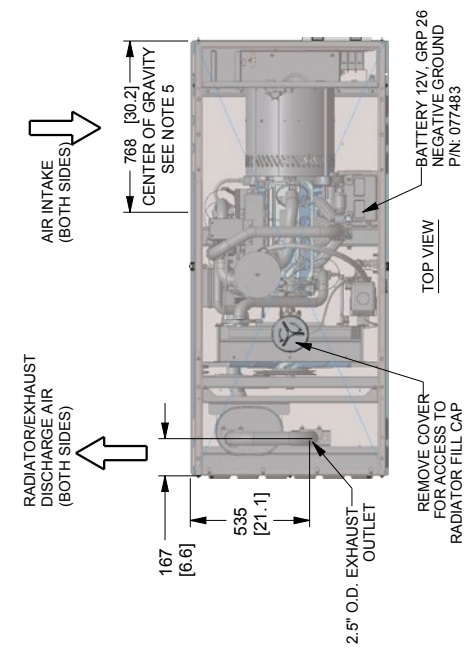

ENGINE/KW	ENCLOSURE MATERIAL	WEIGHT DATA	
		WEIGHT GENSET ONLY KG (LBS)	WEIGHT SHIPPING SKID KG (LBS)
2.4L 32KW	AL	556 [1225]	44 [98]
2.4L 38KW	AL	560 [1235]	44 [98]
			605 [1333]

DIMENSIONS: MM (INCH)

32 & 38 kW

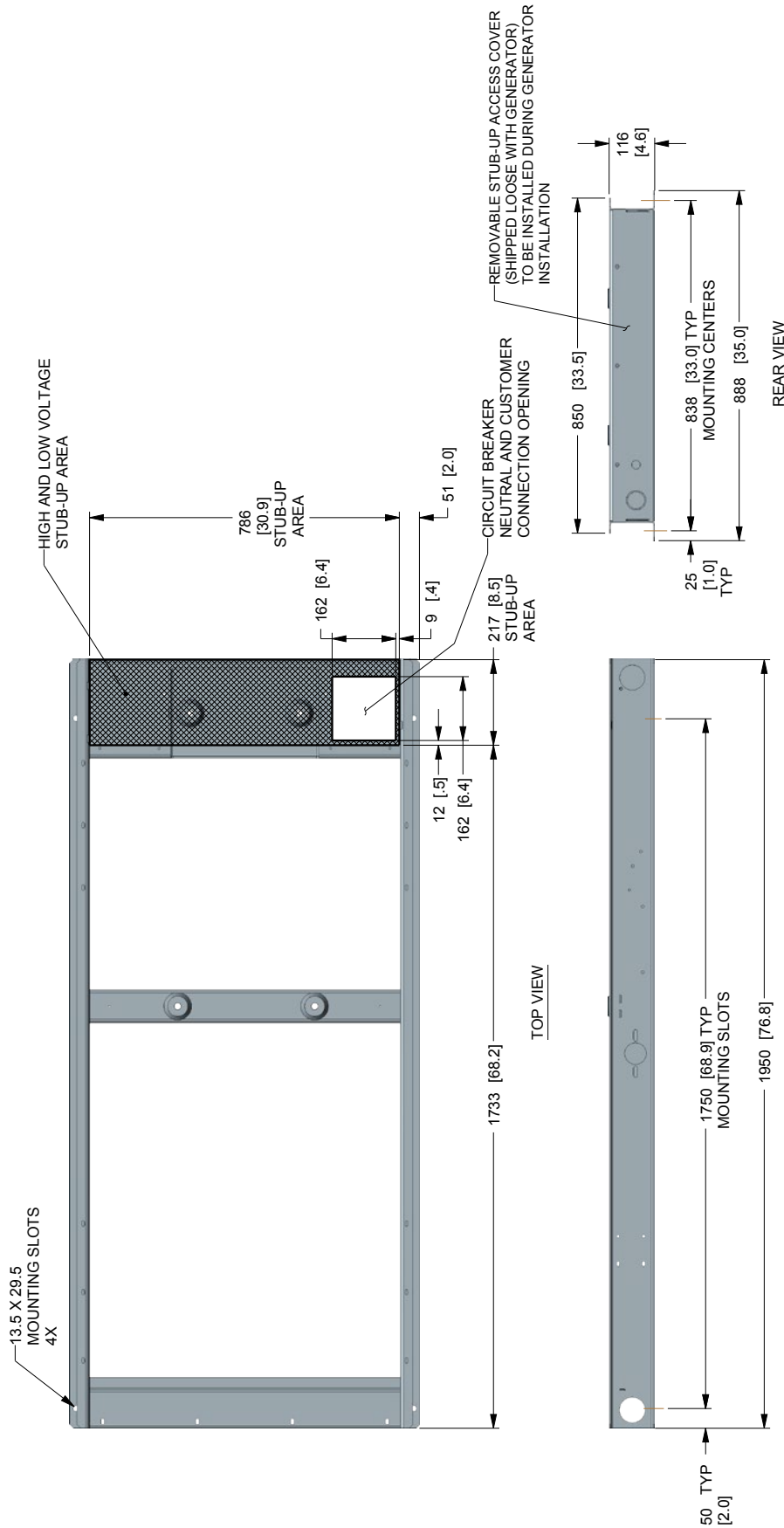

48 kW

Drawing #0K9243-A (1 of 2)

SERVICE ITEM	5.4L
OIL FILL CAP	RIGHT SIDE
OIL DIP STICK	LEFT SIDE
OIL FILTER	LEFT SIDE
OIL DRAIN HOSE	RIGHT SIDE
RADIATOR DRAIN HOSE	LEFT SIDE
COOLANT RECOVERY BOTTLE	LEFT SIDE
RADIATOR FILL CAP	ROOF TOP
AIRCLENER ELEMENT	EITHER SIDE
SPARK PLUGS	EITHER SIDE
MUFFLER	SEE NOTE 11
DRIVE BELT	EITHER SIDE
FAN BELT	SEE NOTE 11
BATTERY	RIGHT SIDE

REFERENCE OWNERS MANUAL FOR PERIODIC REPLACEMENT PART LISTINGS.

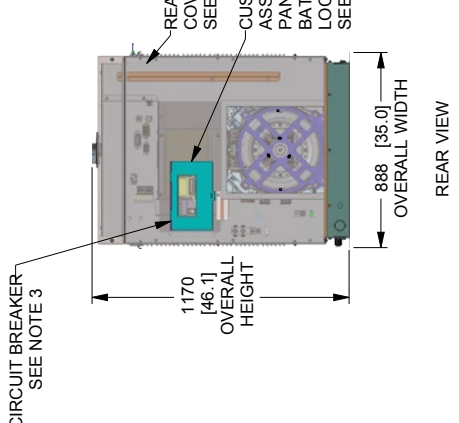
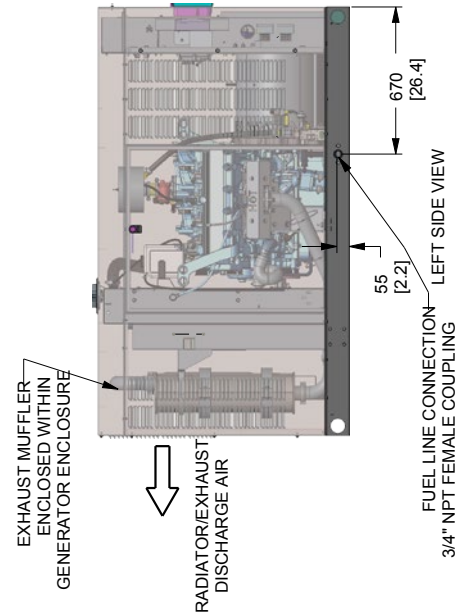
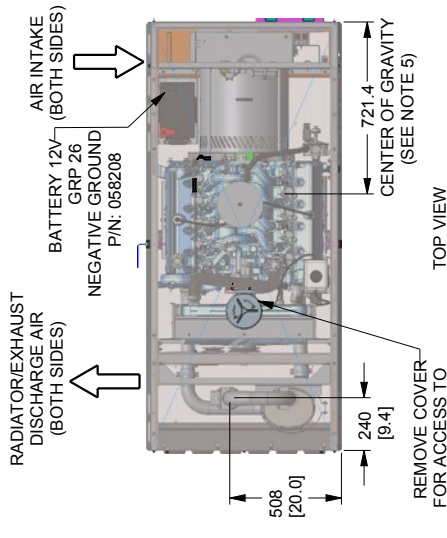

WEIGHT DATA			
ENCLOSURE MATERIAL	WEIGHT GENERATOR ONLY (KG [LBS])	WEIGHT SHIP SKID (KG [LBS])	SHIPPING WEIGHT (KG [LBS])
AL	705 [1555]	44 [98]	750 [1653]

- NOTES:
- MINIMUM RECOMMENDED CONCRETE PAD SIZE: 1194 (47") WIDE X 2256 (88.8") LONG. REFERENCE INSTALLATION GUIDE SUPPLIED WITH UNIT FOR CONCRETE PAD GUIDELINES.
 - ALLOW SUFFICIENT ROOM ON ALL SIDES OF THE GENERATOR FOR MAINTENANCE AND SERVICING. THIS UNIT MUST BE INSTALLED IN ACCORDANCE WITH CURRENT APPLICABLE NFPA 37 AND NFPA 70 STANDARDS AS WELL AS ANY OTHER FEDERAL, STATE, AND LOCAL CODES.
 - CONTROL PANEL / CIRCUIT BREAKER INFORMATION:
 - SEE SPECIFICATION SHEET OR OWNERS MANUAL.
 - ACCESSIBLE THROUGH CUSTOMER ACCESS ASSEMBLY DOOR ON REAR OF GENERATOR.
 - REMOVE THE REAR ENCLOSURE COVER PANEL TO ACCESS THE STUB-UP AREAS AS FOLLOWS:
 - HIGH VOLTAGE CONNECTION INCLUDING AC LOAD LEAD CONDUIT CONNECTION NEUTRAL CONNECTION, BATTERY CHARGER 120 VOLT AC (0.5 AMP MAX) CONNECTION.
 - CENTER OF GRAVITY AND WEIGHT MAY CHANGE DUE TO UNIT OPTIONS.
 - BOTTOM OF GENERATOR SET MUST BE ENCLOSED TO PREVENT PEST INTRUSION AND RECIRCULATION OF DISCHARGE AIR AND/OR IMPROPER COOLING AIR FLOW.
 - REFERENCE OWNERS MANUAL FOR LIFTING WARNINGS.
 - MOUNTING BOLTS OR STUDS TO MOUNTING SURFACE SHALL BE 5/8-11 GRADE 5 (USE STANDARD SAE TORQUE SPECS)
 - MUST ALLOW FREE FLOW OF INTAKE AIR, DISCHARGE AIR AND EXHAUST. SEE SPEC SHEET FOR MINIMUM AIR FLOW AND MAXIMUM RESTRICTION REQUIREMENTS.
 - GENERATOR MUST BE INSTALLED SUCH THAT FRESH COOLING AIR IS AVAILABLE AND THAT DISCHARGE AIR FROM RADIATOR IS NOT RECIRCULATED.
 - EXHAUST MUFFLER AND FAN BELT ENCLOSED WITHIN GENERATOR ENCLOSURE. REMOVE FRONT PANEL TO ACCESS.

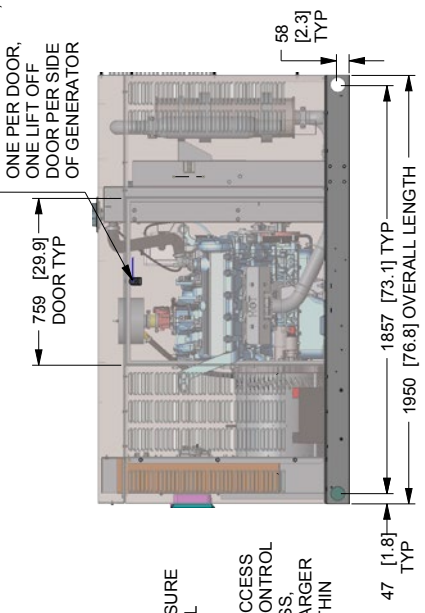

48 kW

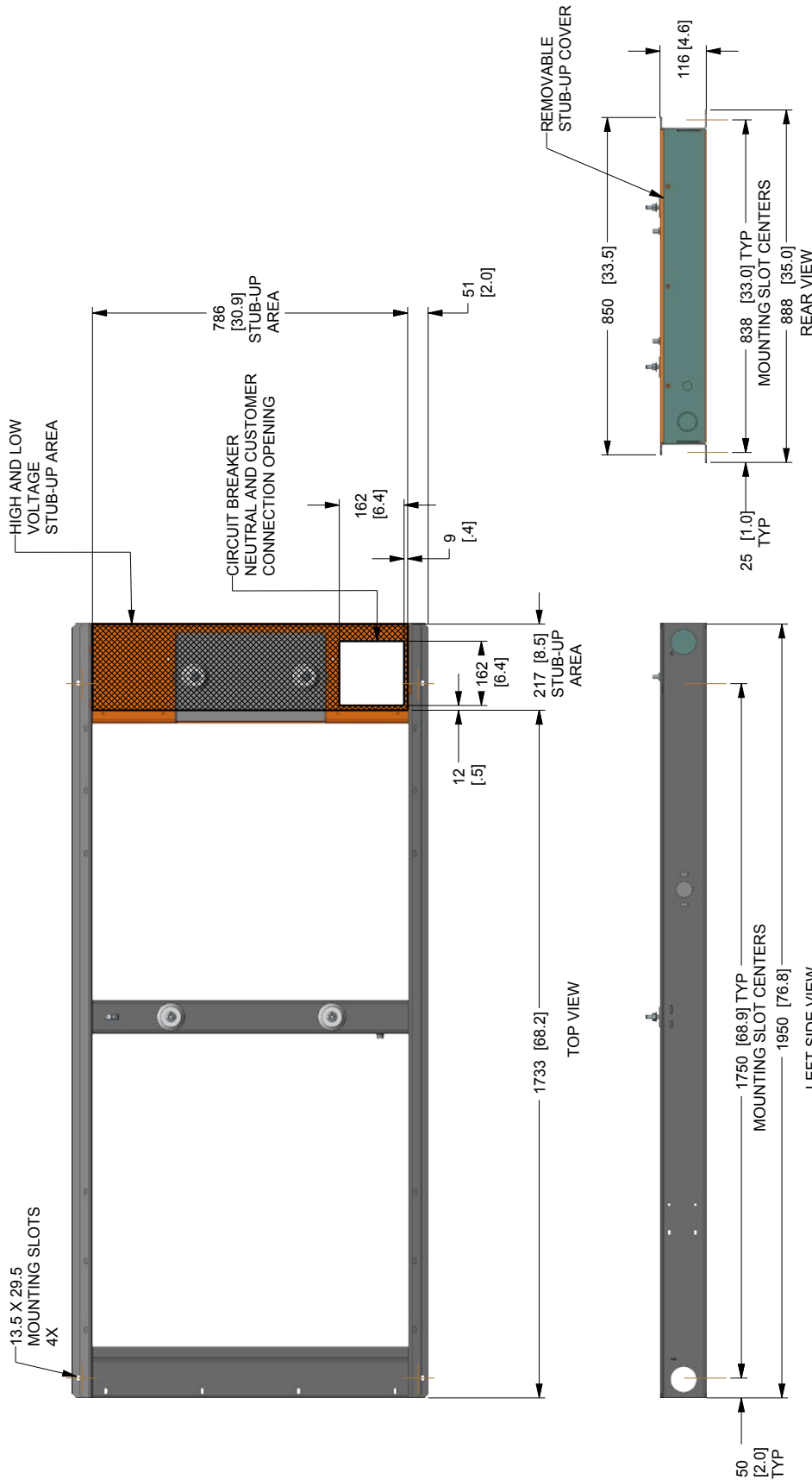

DIMENSIONS: MM [INCH]